

CITIZEN®

取扱説明書

この時計は、バンドをのぞくすべての修理が「メーカー修理」となります。修理、点検の際は弊社お問い合わせ窓口へご依頼ください。

All parts of this watch, excluding the band, are to be repaired only by CITIZEN. Please have all inspections and repairs at a customer support center.

本表的所有零配件，除表带外，其余所有维修仅限在西铁城公司进行。请在客户支持中心进行所有的检查和维修。

Thank you for your purchase of this Citizen watch.
Before using the watch, read this instruction manual carefully to ensure correct use.

After reading the manual, store it in a safe place for future reference.

Visit the Citizen website (<http://www.citizenwatch-global.com/>) to view visual guides for operation of your watch. Some models may be equipped with external features (calculation scale, tachymeter, etc.). Visual guides for operation of such external features can also be found on the website.

To check the movement number

A case number—4 alphanumeric characters and 6 or more alphanumeric characters—is engraved on the case back. (Figure on the right)

The first 4 characters of the case number represent the movement number of the watch. In the example on the right, "△△△△" is the movement number.

Engraving position example

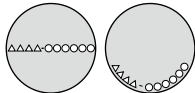



The engraving position may differ depending on watch model.

Safety precautions (IMPORTANT)

This manual contains instructions that should be strictly followed at all times not only for optimal use, but to prevent any injuries to yourself, other persons or property.



We encourage you to read the entire booklet (especially, pages 60 to 69) and understand the meaning of the following symbols:

- Safety advisories are categorized and depicted in this manual as follows:

 DANGER	Highly likely to cause death or serious injury
 WARNING	Can cause serious injury or death
 CAUTION	Can or will cause minor or moderate injury or damage

Safety precautions (IMPORTANT)

- Important instructions are categorized and depicted in this manual as follows:

	Warning (caution) symbol followed by instructions that should be followed or precautions that should be observed.
	Warning (caution) symbol followed by prohibited matters.

Before using this watch

After unpacking, the following must be done before using the watch:

◆ **Checking the power reserve →Page 17**

Check the charge level of the watch.

◆ **Setting the World Time →Page 22**

Select the city for which you want to indicate the time and date.

◆ **Checking the time signal reception →Page 41**

Check the result of the time signal reception.

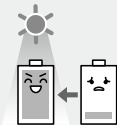

This watch has a rechargeable cell which is charged by exposing the dial to light.

Expose the dial to light regularly to charge the watch.
For details of charging, see pages 12 to 19.

◆ **Protective Stickers**

Be sure to remove any protective stickers that may be on your watch (case back, band, clasp, etc.). Otherwise, perspiration or moisture may enter the gaps between the protective stickers and the parts, which may result in a skin rash and/or corrosion of the metal parts.

◆ **Band adjustment**

We do not recommend attempting to adjust the watch band yourself. If not adjusted correctly, the band may become detached leading to an injury or loss of your watch. (Some retailers may supply a band adjustment tool with your purchase).

For band adjustment, we recommend you consult the retailer where the watch was purchased or Authorized Citizen Service Center.

Some repair shops may charge a nominal fee for adjustment if the watch was not purchased directly from them.





Before using this watch

◆ How to use a specially designed crown/push button

Some models are equipped with a specially designed crown and/or push button to prevent accidental operation.

Screw down crown and screw down push button

Unlock the crown prior to operate your watch.

	Unlock	Lock
Screw down crown	 <p>Rotate the crown counterclockwise until it releases from the case.</p>	 <p>Push the crown in to the case. With gentle pressure towards the case, rotate the crown clockwise to secure it to the case. Be sure to tighten firmly.</p>
Screw down push button	 <p>Rotate the locking screw counterclockwise, and loosen until it stops.</p>	 <p>Rotate the locking screw clockwise, and tighten firmly.</p>

Recessed buttons

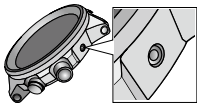

Press the button with a narrow-tipped object such as a wooden toothpick.

Table of contents

Features	10
Component identification	11
Charging your watch.....	12
Using the chronograph.....	20
Setting the World Time	22
Setting Summer Time	26
Notes on the time signal reception	33
Checking the time signal reception.....	41
Receiving the time signal manually (On demand reception)	43
Adjusting the time/calendar manually	45
Checking and correcting the current reference position	50

Troubleshooting	54
Eco-Drive (solar powered) watch handling precautions	60
Water resistance	62
Precautionary items and usage limitations	64
Information	70
Warranty and service	72
Specifications	74
Customer support center	76

Features

"Radio controlled watch"

Receives a time signal from one of the five signal stations located in four regions and automatically adjusts the time and calendar.



"World Time"

Easy to see the time and calendar of cities all over the world.



"Eco-Drive"

No need for periodical changing of rechargeable cells. The watch is charged by light.



Chronograph

Measures the elapsed time up to 60 minutes.

Perfex
パーフェックス

"Perfex"

Preventing the hands from unwanted movement due to impacts or magnetism, the accuracy of the radio controlled watch is maintained.



"Perpetual calendar"

No need for date correction at the end of each month.

The leap year is also updated automatically.

* "Eco-Drive" and "Perfex" are Citizen original technologies.

Component identification

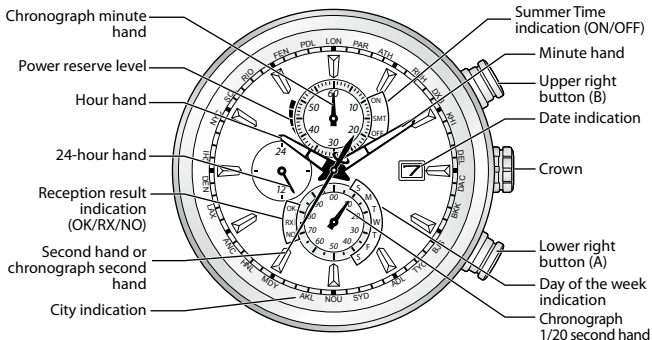

* The illustrations in this instruction manual may differ from the actual appearance of your watch.

* A solar cell is placed under the dial.

Charging your watch

This watch has a rechargeable cell which is charged by exposing the dial to light, such as direct sunlight or fluorescent lamps.

After taking off the watch, put it in a location where the dial is exposed to bright light, such as by a window.

The watch can be charged effectively when the dial is exposed to sunlight as shown in the figure.

For optimal performance, be sure to:

- Charge the watch by exposing it to direct sunlight for five to six hours at least once a month.
- Avoid leaving the watch in a dark place for long periods of time.

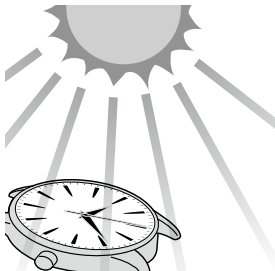

- If the watch is obscured from light by long sleeves frequently, supplemental charging may be needed to ensure continual operation.
- Do not charge the watch at high temperature (about 60°C or higher).

Charging your watch

◆ When the watch reaches a low charge state (insufficient charge warning function)

When the power reserve becomes low, the second hand moves once every two seconds. This is the insufficient charge warning function. Be sure to fully charge your watch.

- When the watch is sufficiently charged, the second hand will move normally.
- If you do not charge the watch for 2 days or longer after the insufficient charge warning movement has begun, the watch will be depleted of all power and stop.

- When in the insufficient charge warning state, the current time and date are indicated. However, you cannot configure or confirm settings, or operate the chronograph.

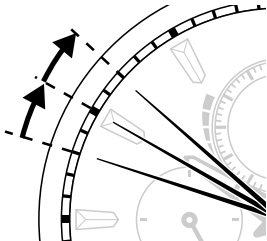

◆ Charging time by environment

Below are the approximate times required for charging when exposing the watch dial to light continuously. Please use this table as a reference only.

Environment	Illuminance (lx)	Charging time (approx.)		
		To work for one day	To start working normally when the cell is discharged	To become fully charged when the cell is discharged
Outdoors (sunny)	100,000	5 minutes	40 minutes	30 hours
Outdoors (cloudy)	10,000	11 minutes	1 hour	40 hours
20 cm (7-7/8 inches) from a fluorescent lamp (30W)	3,000	40 minutes	2.5 hours	130 hours
Interior lighting	500	4 hours	14 hours	920 hours

Maximum run time from full charge: Approx. 6 months (in normal operation), approx. 10 months (with power save feature)

Charging your watch

◆ Power save feature

When the watch is not exposed to light for 30 minutes or longer, such as when you store it in a dark place, the second hand automatically stops to save the power. However, the watch continues to work internally.

- When the crown is in position 1 or 2, the power save feature will not activate.
- The power save feature can not be activated manually.

◆ To cancel the power save feature

When the watch is exposed to light sufficient for charging, the power save feature is automatically canceled and normal time indication will resume.

◆ Checking the power reserve

Check the current power reserve.

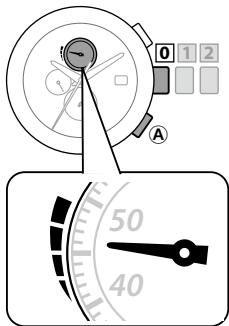





1. Ensure that the crown is in position **0** .
2. Press the lower right button **(A)** .
The chronograph minute hand moves to indicate the power reserve.
 - For details on the power reserve level, see the next page.
3. Press the lower right button **(A)** to finish the check procedure.
 - The current time indication will resume automatically when leaving the watch for approx. 10 seconds.

You can not perform this operation when using the chronograph.

Charging your watch

The power reserve level

Level	3	2	1	0
Power reserve level				
Approximate duration of operation at each level	Approx. 180 to 130 days	Approx. 130 to 30 days	Approx. 30 to 2 days	Approx. 2 days
	Power reserve is sufficient for all features and functions. Optimal performance is achieved at this level.	Power reserve is sufficient for all operations at this level.	Power reserve is getting low. The watch should be fully charged to ensure optimal performance.	Power reserve is not sufficient for normal operation. The watch must be fully charged.
				The watch must be charged immediately.

- When the power reserve is at level 1 or 0, the chronograph minute hand always indicates the power reserve level.
- When the power reserve is at level 0, the current time and date are indicated. However, you cannot configure or confirm settings, or operate the chronograph.

Using the chronograph

The chronograph can measure up to 60 minutes in units of 1/20 seconds.

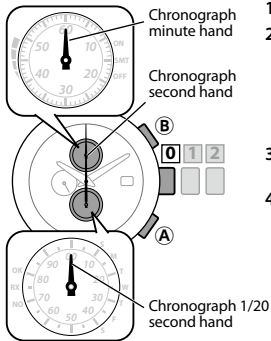

1. Ensure that the crown is in position **0** .

2. Press the upper right button **(B)** .

The watch enters the chronograph mode.

- As shown in the figure, the chronograph minute, chronograph second, and chronograph 1/20 second hands point in the 12 o'clock direction.

3. Press the upper right button **(B)** to start measurement.

4. Press the upper right button **(B)** to suspend measurement.

- Pressing the upper right button **(B)** again will resume the measurement operation.

- 5. Press the lower right button **A** to reset the measured time.**
 - Make sure to reset the time after finishing measurement.
- 6. Press the lower right button **A** again to return to current time indication.**
 - The current time indication will resume automatically when leaving the watch for approx. 3 hours.

- When 30 seconds have elapsed after the measurement is started (or restarted), the chronograph 1/20 second hand stops at the zero second position. However, the measurement is still conducted.
- The chronograph cannot be used when the power reserve is at level 0. Even when the power reserve is at level 1, we recommend charging the watch before using the chronograph.
- Do not pull out the crown during chronograph measurement operation. The measurement will stop.

Setting the World Time

The watch can indicate the time and date of any of the 26 cities in the world you choose.

- When using the watch in an area not listed in the table below, select and set the city with the same time difference.

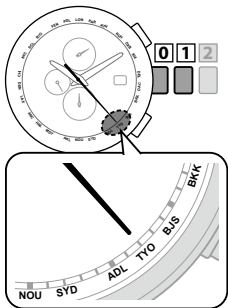

1. Pull the crown out to position **1**.

The second hand indicates the current city setting; the chronograph minute hand indicates the summer time ON/OFF setting; and the chronograph 1/20 second hand indicates the summer time auto/manual setting.

- Setting Summer Time → Page 26

2. Rotate the crown to select the city for which you want to indicate the time and date.

- Move the second hand to select the city by referring to "second hand position" in the city indication table.

3. Push the crown in to position **0** to finish the setting.

◆ City indication table

Abbreviation	City indication or second hand position		Time difference	Signal from...
LON	*	LONDON	0 sec.	Germany
PAR	*	PARIS	2 sec.	
ATH	*	ATHENS	4 sec.	
RUH		RIYADH	7 sec.	
DXB		DUBAI	9 sec.	
KHI		KARACHI	11 sec.	China
DEL		DELHI	14 sec.	
DAC		DACCA	16 sec.	
BKK		BANGKOK	18 sec.	
BJS/HKG		BEIJING/HONGKONG	21 sec.	

Setting the World Time

Abbreviation	City indication or second hand position		Time difference	Signal from...
TYO	TOKYO	23 sec.	+9	Japan
ADL	ADELAIDE	25 sec.	+9.5	
SYD	SYDNEY	28 sec.	+10	
NOU	NOUMEA	30 sec.	+11	
AKL	AUCKLAND	32 sec.	+12	
MDY	MIDWAY ISLANDS	35 sec.	-11	USA
HNL	HONOLULU	37 sec.	-10	
ANC	** ANCHORAGE	39 sec.	-9	
LAX	** LOS ANGELES	42 sec.	-8	
DEN	** DENVER	44 sec.	-7	
CHI	** CHICAGO	46 sec.	-6	
NYC	** NEW YORK	49 sec.	-5	

Setting the World Time

Abbreviation	City indication or second hand position		Time difference	Signal from...
SCL	SANTIAGO	51 sec.	-4	USA
RIO	RIO DE JANEIRO	53 sec.	-3	
FEN	FERNANDO DE NORONHA	56 sec.	-2	Germany
PDL	* AZORES	58 sec.	-1	

- The city indications displayed on the watch may be different, depending on the model.
- For a city indicated by *, the summer time indication and the standard time indication are linked together.
- For a city indicated by **, the summer time indication and the standard time indication are linked together.
- The time difference in the table above is based on UTC.
- The time difference may change depending on the country or area.

Setting Summer Time

◆ Summer time

Summer Time is a system adopted in some countries/areas to gain an extra hour of daylight during summer by advancing clocks by one hour. In an area where the summer time is in effect, the time signal contains a summer time check signal. When receiving the summer time check signal, this watch automatically enables/disables (turns ON/OFF) the Summer Time setting.

- Summer Time can be manually disabled in an area where the time signal can be received but the summer time is not in effect. (See pages 30 and 31.)
- Summer Time can be manually enabled even if the watch is outside the area. (See pages 30 and 31.)

- The summer time rules may change depending on the country or area.
- A summer time period is different depending on the country or area.

◆ Checking the time currently shown

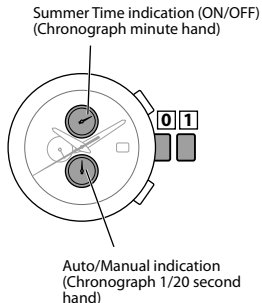





1. Pull the crown out to position **1** .

The second hand indicates the current city setting; the chronograph minute hand indicates the summer time ON/OFF setting; and the chronograph 1/20 second hand indicates the summer time auto/manual setting.

- Check the settings by referring to the table in the next page.

Setting Summer Time

Summer Time indication (ON/OFF) (Chronograph minute hand)	Auto/Manual indication (Chronograph 1/20 second hand)	Description
<p>Enable Summer Time (ON)</p>  <p>Enable Standard Time (OFF)</p> 	<p>Automatic setting (12 o'clock direction)</p> 	<p>Automatically switch between Summer Time and Standard Time by receiving the signal.</p> <ul style="list-style-type: none"> When a summer time check signal is received, the summer time ON/OFF setting is changed.
	<p>Manual setting (6 o'clock direction)</p> 	<p>Manually switch between Summer Time and Standard Time.</p> <ul style="list-style-type: none"> Even if a summer time check signal is received, the summer time ON/OFF setting is not changed.

- Switching ON/OFF of Summer Time → (See page 30)
- Auto/manual switching of Summer Time → (See page 31)

Setting Summer Time

To automatically enable Summer Time when using the watch in an area where the time signal can be received:

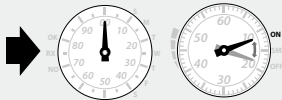

Set the auto/manual setting to auto (the watch will automatically change the summer time ON/OFF setting when receiving a summer time check signal.)

To enable Summer Time manually when the time signal can not be received:

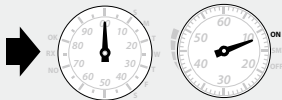

Turn the summer time ON/OFF setting to ON when you want to enable Summer Time.

To prevent the watch from automatically enabling Summer Time through signal reception:

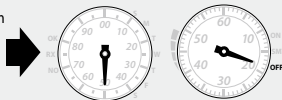

Set the auto/manual setting to manual and turn the summer time ON/OFF setting to OFF.

Setting Summer Time

◆ Switching ON/OFF of Summer Time

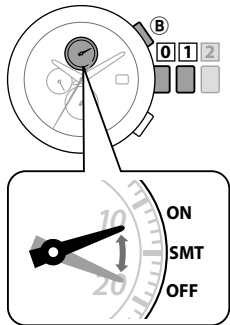

1. Pull the crown out to position **1**.

The chronograph minute hand indicates the current summer time ON/OFF setting.

2. Press the upper right button **(B)** to switch the summer time setting.

Each time you press the upper right button **(B)**, the chronograph minute hand points **SMT ON** and **SMT OFF** alternately to indicate the summer time ON/OFF setting is switched.

3. Push the crown in to position **0** to finish the setting.

◆ Auto/manual switching of Summer Time

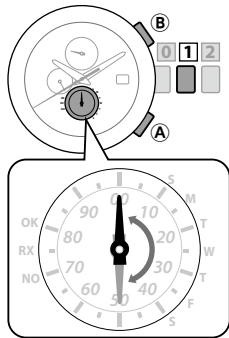

1. Pull the crown out to position **1** .

The chronograph 1/20 second hand indicates the current auto/manual setting.

2. Press and hold the lower right button **A** for two or more seconds.

Each time you hold down the lower right button **A** for two or more seconds, the chronograph 1/20 second hand points **the 12 o'clock direction (auto)** and **the 6 o'clock direction (manual)** alternately.

While manual setting is enabled, the summer time ON/OFF setting is not changed even when the watch receives the time signal. Take the procedure described in the previous page to change the ON/OFF setting.

3. Push the crown in to position **0** to finish the setting.

Setting Summer Time

◆ The time shown for each city

The watch shows and memorizes Summer Time/standard time in common for the following cities/time differences in each area so you do not need to change them for each city/time differences.

- If you show the standard time manually for a city/time differences, the watch always shows the standard time for that city/time difference regardless of the time shown for others in the same area.

Areas receiving the signal from USA	
City	Time difference
Anchorage/ANC	-9
L.Angeles/LAX	-8
Denver/DEN	-7
Chicago/CHI	-6
New York/NYC	-5

Areas receiving the signal from Germany	
City	Time difference
London/LON	0
Paris/PAR	+1
Athens/ATH	+2
Azores/PDL	-1

For cities/time differences other than those listed above, the time shown last is memorized for each.

Notes on the time signal reception

There are three ways to receive the time signal:

The second hand indicates the reception result (OK/NO). (See page 41)

Methods	Explanations
Automatic reception	Receives the signal at 2:00 a.m. every day. If reception is unsuccessful, the watch tries to receive at 3:00 a.m.
On demand reception	Starts receiving the signal when you want to adjust the time and date. (See page 43.)
Recovery automatic reception	Automatically receives the signal once after charging when the watch stops due to insufficient charge.

- Even when this watch receives the time signal successfully, the accuracy of the displayed time will be dependent on the reception environment and internal processing.
- If the watch is not able to receive the signal, it will operate normally within an accuracy range of ± 15 seconds per month.

Notes on the time signal reception

◆ When receiving the time signal

Remove the watch and place it on a stable surface where it can receive the signal better, such as next to a window.

- The reception antenna is located at the 9:00 position of the watch. Place the watch with the 9:00 position facing toward the station.
- Do not move the watch during time signal reception.
- The watch will not receive the time signal when in a low charge state as indicated by the second hand moving in two second increments (the insufficient charge warning). Charge the watch before reception.

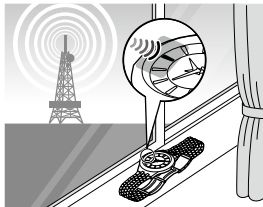

◆ Note on the time signal

This watch receives the time signal from one of the five signal stations located in four regions, and automatically corrects the time and date.

The receivable signal stations are listed as follows:

Signal stations	Kind of the time signal
Fukushima station, Japan	JJY
Kyushu station, Japan	
Fort Collins station, Denver, Colorado, USA	WWVB
Mainflingen station, Southeast Frankfurt, Germany	DCF77
Shangqiu station, Henan, China	BPC

- Refer to the maps on pages 36 to 38 to see the locations of the signal stations and their receivable area roughly.

Notes on the time signal reception

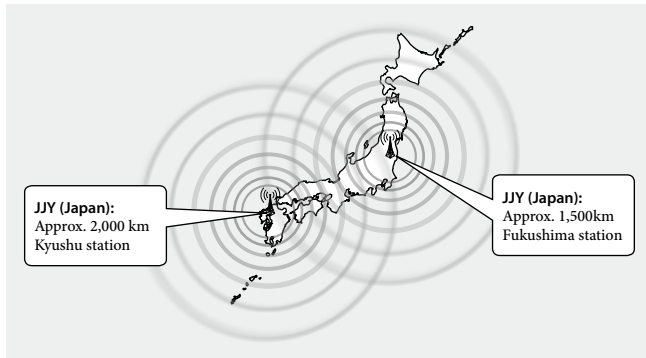

Notes on the time signal reception

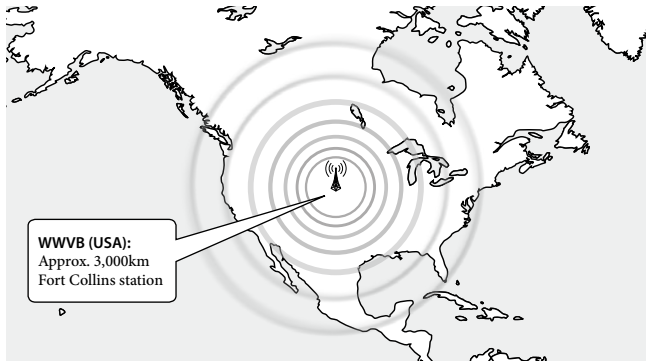

Notes on the time signal reception

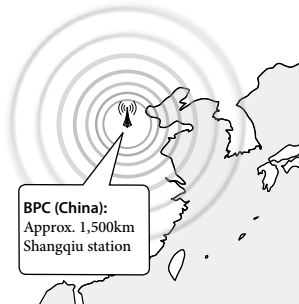
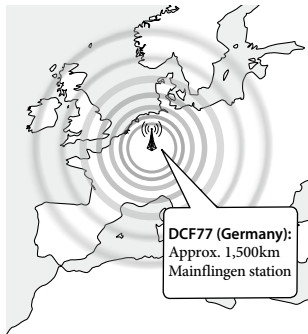

◆ Poor reception areas

It may be difficult to receive the time signal properly under certain environmental conditions or in areas susceptible to radio noise.

- Extremely hot or cold locations



- Inside vehicles



- Near electrical equipment or office appliances



- Near high-tension electrical lines, railway overhead wires or communication facilities



- Inside reinforced concrete buildings, between tall buildings, mountains, or underground



- Near mobile phones that are in use



Notes on the time signal reception

◆ When signal reception is poor

High-tension electrical lines or other structures near your house may block the path to the signal station. This may result in a poor environment for receiving the time signal.

With reference to pages 36 to 38, search for a better place for reception.

Then, attempt to receive the time signal following the procedure on page 43.

- If the window contains a wire netting in it, open the window or change the location for better reception.
- We can provide customers having trouble in signal reception with maps showing directions of signal stations upon request.
Contact the Citizen Consumer Help Desk (TEL: 0120-78-4807).

Checking the time signal reception

Check the result of the last signal reception.

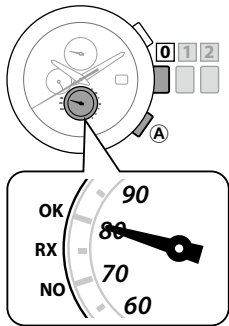

1. Ensure that the crown is in position **0** .
2. Press the lower right button **A** .
The chronograph 1/20 second hand indicates the signal reception result.
 - For details on the reception result, see the next page.
3. Press the lower right button **A** to finish the check procedure.
 - The current time indication will resume automatically when leaving the watch for approx. 10 seconds.

You can not perform this operation when using the chronograph.

Checking the time signal reception

◆ Time signal reception result

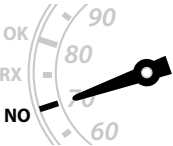
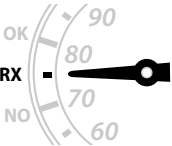
Indication	 A semi-circular gauge with a scale from 60 to 90. The needle points to the 'OK' mark, which is positioned between 80 and 90. The 'RX' mark is between 70 and 80, and the 'NO' mark is between 60 and 70.	 A semi-circular gauge with a scale from 60 to 90. The needle points to the 'NO' mark, which is positioned between 60 and 70. The 'RX' mark is between 70 and 80, and the 'OK' mark is between 80 and 90.	 A semi-circular gauge with a scale from 60 to 90. The needle points to the 'RX' mark, which is positioned between 70 and 80. The 'NO' mark is between 60 and 70, and the 'OK' mark is between 80 and 90.
Result	OK	NO	RX
Meaning	Reception has succeeded.	Reception has failed. The time and data/ calendar have not been corrected.	Receiving

- For details on time signal reception, see page 33.

Receiving the time signal manually (On demand reception)

You can adjust the watch by receiving the time signal any time when the time and date are not correct or the reception result is "NO."

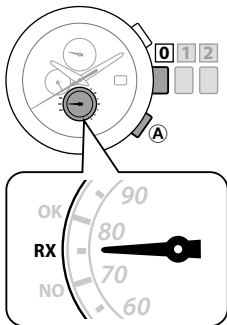

- The signal station is different depending on the city set. Confirm the current city setting.
- You can not perform this operation when using the chronograph.

1. Ensure that the crown is in position **0** .
2. Press and hold the lower right button **A** for two or more seconds.

The result of the last signal reception is displayed, then on-demand reception starts. (2-30 minutes)

- The chronograph 1/20 second hand indicates "RX."

Receiving the time signal manually (On demand reception)

- The watch will not receive the time signal when in a low charge state as indicated by the second hand moving in two second increments (the insufficient charge warning).
- If the current location is different from the city you set, the watch will not receive the time signal.
- Press and hold the lower right button (A) for two or more seconds to cancel the signal reception.
- The reception operation is complete when normal time indication resumes.

Adjusting the time/calendar manually

Manually adjust the time/calendar when the watch cannot receive the time signal.

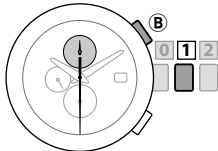

1. Pull the crown out to position **1**.
2. Press and hold the upper right button **B** for two or more seconds.

The second hand moves to the 30-second position and the chronograph minute hand moves to the 60-minute position.

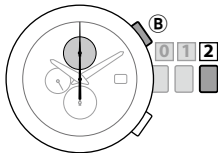

3. Pull the crown out to position **2**.
The second hand moves to the 0 second position, and it becomes possible to adjust the time/calendar.

Adjusting the time/calendar manually

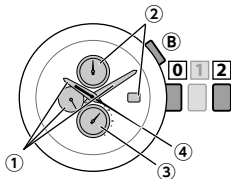

4. Press the upper right button (B) to select the correction target.

Each time you press the upper right button (B), the correction target changes as follows and the corresponding hand slightly moves.

- ① Time (minutes/hours/24 hour time) → ② date →
③ day of the week → ④ year and month → back to ①

① Time

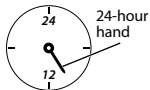

The minute, hour, 24-hour hands move in conjunction with one another.

② Date

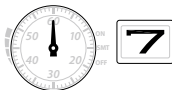

When the chronograph minute hand rotates five times, the date advances by one day.

③ Day of the week

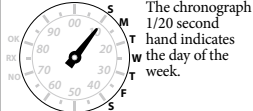

④ Year and month

5. Rotate the crown to adjust each setting.

- If you spin the crown quickly, the hands for the time and date will move continuously. To slow down and stop them, slightly rotate the crown.
- To move the date forward or backward by one day, slightly rotate the crown.
- The date changes at around 0:00 am. It takes about five seconds for the displayed date to completely change.
- The year and month are indicated by the minute hand. Adjust them by referring to the figure in the next page.

6. Repeat procedures 4 and 5.

7. Push the crown in to position **0** to finish the setting.

The second hand starts moving from the 0 second position, and time/calendar indication will resume.

- Push in the crown by referring to a reliable time source.

Adjusting the time/calendar manually

◆ Month and year indications

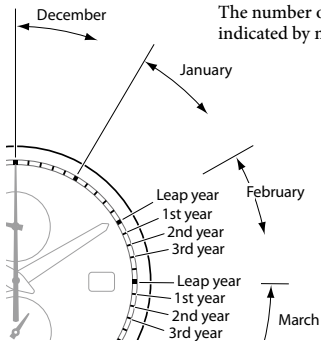

The number of years and months since the leap year is indicated by minute marks.

[Month]

December: between 12:00 and 01:00

January: between 01:00 and 02:00

February: between 02:00 and 03:00

[Year]

Leap year:

Hour marker in each month

1st year since leap year:

1st min. marker in each month

2nd year since leap year:

2nd min. marker in each month

3rd year since leap year:

3rd min. marker in each month

Adjusting the time/calendar manually

You can get the actual year from the number of years passed from the leap year by referring to the following table:

Indication of the second hand	Passed year	Year
Hour marker	Leap year	2012, 2016, 2020
1st min. marker	1st year	2013, 2017, 2021
2nd min. marker	2nd year	2014, 2018, 2022
3rd min. marker	3rd year	2015, 2019, 2023

Checking and correcting the current reference position

◆ What is the reference position?

The base position for all the hands to indicate the time and date. If the reference position is not at the correct position, the time and functions are not indicated correctly.

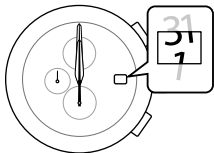
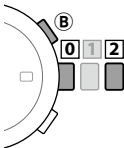

Figure: Correct reference positions

- Hands: All point in the 12 o'clock direction.
- Date: Between "31" and "1"

Checking and correcting the current reference position

◆ Checking and correcting the current reference position



1. Ensure that the crown is in position **0** .
2. Press and hold the upper right button **B** for ten seconds.

All hands and the date indicator move to indicate the current reference position.

Correct the reference position by taking the following steps if the position is not accurate.

3. Pull the crown out to position **2** .

This will enable you to correct the reference position.

Checking and correcting the current reference position

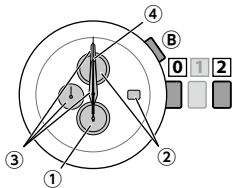

4. Press the upper right button (B) to select the correction target.

Each time you press the upper right button (B), the correction target changes as follows and the corresponding hand slightly moves.

- 1 Chronograph 1/20 second hand →
- 2 Chronograph minute hand/date indication →
- 3 Minute hand/hour hand/24-hour hand →
- 4 Second hand → back to 1 →

1 Chronograph 1/20 second hand



2 Chronograph minute hand/date indication



The chronograph minute hand and the date indication move in conjunction with each other.

3 Minute hand/hour hand/24-hour hand

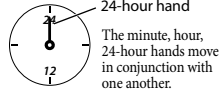

4 Second hand

Checking and correcting the current reference position

5. **Rotate the crown to correct the reference position of the active hand/ indication.**
 - When you rotate the crown quickly, each hand will move continuously. To slow down and stop them, slightly rotate the crown.
6. **Push the crown in to position **0** to finish the correction.**
7. **Press the upper right button **B** to return to current time indication.**

Troubleshooting

If you have a problem with your watch, check the table below.

Problems with time signal reception.

Symptoms	Remedies	Page
Reception is unsuccessful in a receivable area.	Push the crown in to position 0 .	—
	Avoid things likely to interfere with the time signal and place the watch with the 9:00 position facing toward the station.	34, 39
	Do not move the watch until the reception has finished.	34
	When the second hand moves once every two seconds, the watch cannot receive the time signal. Charge the watch.	14
	Contact Citizen Consumer Help Desk.	77
The correct time and date are not indicated after successful reception.	Check and correct the current reference position.	51
	Check the city setting.	22
	Check the summer time setting.	27

The hands do not work properly.

Symptoms	Remedies	Page
The hands move in an unexpected direction.	Stop the chronograph.	20
The second hand moves once every two seconds.	Charge the watch.	14
All hands stop moving.	Push the crown in to position [0] .	—
	Charge the watch by exposing it to direct sunlight until the second hand starts moving once every one seconds. After charging, signal reception automatically starts. (Recovery automatic reception)	14
The watch does not enter the chronograph mode.	The chronograph cannot be used when the power reserve is at level 0. Charge the watch.	12
The chronograph minute hand does not point in the 12 o'clock direction.	When the power reserve is insufficient, level 1 is displayed for the power reserve. Charge the watch.	12
The hands start turning rapidly as you take the watch out of the case.	The watch is canceling the power save feature. Wait until the rapid movement stops.	16

Troubleshooting

The time and/or date is incorrect.

Symptoms	Remedies	Page
The time and/or date is incorrect.	Check the city setting.	22
	Change the summer time setting.	27
	Check and correct the current reference position.	51
	Receive the time signal to adjust the time and date.	43
	Set the time and date manually.	45
The date changes at around 12:00 p.m.	Check and correct the current reference position.	51
	Receive the time signal to adjust the time and date.	43
	Adjust the time manually.	45

Others

Symptoms	Remedies	Page
The hands do not move even if the watch is charged.	Charge the watch by exposing it to direct sunlight for five to six hours. If the problem is not solved after charging, contact the Customer Support Center or the store where you purchased your watch.	12, 77

◆ All Reset

When the watch does not work properly, you can reset all the settings. If the power reserve is insufficient, charge the watch first.

Check before performing All Reset.

After performing All Reset, you need to configure all the settings again. Set the watch again by following the procedures below.

1. Correct the reference position. See page 51.

2. Set the city. See page 22.

- To set Summer Time, see page 27.

3. Set the time.

To adjust the time by receiving the time signal, see page 43. To adjust the time manually, see page 45.

◆ Performing All Reset

Perform this operation after checking the contents of the previous page in this manual.

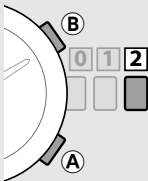

1. Pull the crown out to position **2**.
2. Hold down both the lower right button **A** and the upper right button **B** for four or more seconds.

All Reset will be performed.

The settings will be reset as follows:

The settings after All Reset

- **Reference positions of hands/date** : Positions when the crown is pushed in.
- **Calendar** : Leap year, January/Sunday
- **City** : LON (London)
- **Summer Time** : OFF (Standard time)
- **Switching of Summer Time** : Auto

Eco-Drive (solar powered) watch handling precautions

<Always Make Sure to Recharge Frequently>

- Please note that if you wear long sleeves, the watch may stop as a result of being covered by your sleeve and blocked from the light.
- When you take off the watch, try to place it in as bright a location as possible. This will ensure optimal operation.

CAUTION Recharging Precautions

- Do not charge the watch at a high temperature (about 60°C/140°F or higher) as doing so may cause the movement to malfunction.

Examples:

- Charging the watch too close to a light source which generates a large amount of heat such as an incandescent lamp or halogen lamp.
- * When charging under an incandescent lamp, be sure to leave 50 cm (19-11/16 inch) or more between the lamp and the watch to avoid exposing the watch to excessive heat.
- Charging the watch in a location where the temperature may become extremely high such as on the dashboard of a vehicle.

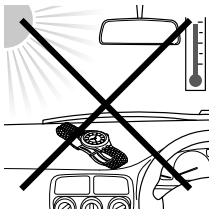

Eco-Drive (solar powered) watch handling precautions

<Replacement of Rechargeable Cell>

- This watch utilizes a special rechargeable cell that does not require regular replacement. However power consumption may increase after using the watch for a number of years due to wear of internal components and deterioration of oils. This may cause stored power to be depleted at a faster rate. For optimal performance, we recommend having your watch inspected (chargeable to the owner) by an Authorized Service center to ensure operation is within factory specifications.



WARNING Handling of Rechargeable Cell

- The rechargeable cell should never be removed from the watch.
If for any reason it becomes necessary to remove the rechargeable cell from the watch, keep out of the reach of children to prevent accidental swallowing.
If the rechargeable cell is accidentally swallowed, consult a doctor immediately.
- Do not dispose of the rechargeable cell with ordinary garbage. Please follow the instructions of your municipality regarding collection of batteries to prevent the risk of fire or environmental contamination.



WARNING Use Only the Specified Battery

- Never use a battery other than the rechargeable cell specified for use in this watch. Although the watch structure is designed so that it will not operate when another type of battery is installed, if a silver battery or other type of battery is installed in the watch and the watch is recharged, there is the risk of overcharging which may cause the battery to rupture. This can cause damage to the watch and injury to the wearer. When replacing the rechargeable cell, always make sure to use the designated rechargeable cell.

Water resistance





WARNING Water Resistance

- Refer to the watch dial and the case back for the indication of the water resistance of your watch. The following chart provides examples of use for reference to ensure that your watch is used properly. (The unit "1bar" is roughly equal to 1 atmosphere.)
- WATER RESIST(ANT) $\times\times$ bar may also be indicated as W.R. $\times\times$ bar.
- Non-water resistant models are not designed to come into contact with any moisture. Take care not to expose a watch with this rating to any type of moisture.
- Water resistance for daily use (to 3 atmospheres) means the watch is water resistant for occasional accidental splashing.

Name	Indication	Specification
	Dial or Case back	
Non-water resistant watch	—	Non-water resistant
Everyday-use water resistant watch	WATER RESIST(ANT)	Water resistant to 3 atmospheres
Upgraded everyday-use water resistant watch	WATER RESIST(ANT) 5 bar	Water resistant to 5 atmospheres
	WATER RESIST(ANT) 10/20 bar	Water resistant to 10 or 20 atmospheres

Water resistance

- Upgraded water resistance for daily use (to 5 atmospheres) means that the watch may be worn while swimming, but is not to worn while skin diving.
- Upgraded water resistance for daily use (to 10/20 atmospheres) means that the watch may be worn while skin diving, but not while scuba or saturated diving using helium gas.

Water-related use				
 Minor exposure to water (washing face, rain, etc.)	 Swimming and general washing work	 Skin diving, marine sports	 Scuba diving using an air tank	 Operate the crown or button when the watch is wet
NO	NO	NO	NO	NO
OK	NO	NO	NO	NO
OK	OK	NO	NO	NO
OK	OK	OK	NO	NO

Precautionary items and usage limitations

CAUTION To Avoid Injury

- Be particularly careful when wearing your watch while holding a small child, to avoid injury.
- Be particularly careful when engaged in strenuous exercise or work, to avoid injury to yourself and others.
- Do NOT wear your watch while in a sauna or other location where your watch may become excessively hot, since there is the risk of burns.
- Be careful when putting on and taking off your watch, since there is a risk of damaging your fingernails, depending on the manner in which the band is fastened.
- Take off your watch before going to bed.

CAUTION Precautions

- Always use the watch with the crown pushed in (normal position). If the crown is of the screw lock-type, make sure it is securely locked.
- Do NOT operate the crown or any push buttons when the watch is wet. Water may enter the watch causing damage to vital components.
- If water enters the watch or the watch fogs up and does not clear up even after a long time, consult your dealer or Authorized Service Center for inspection and/or repair.

Precautionary items and usage limitations

- Even if your watch has a high level of water resistance, please be careful of the following.
 - If your watch is immersed in sea water, rinse thoroughly with fresh water and wipe with a dry cloth.
 - Do not pour water from a tap directly onto your watch.
 - Take off your watch before taking a bath.
- If seawater enters the watch, place the watch in a box or plastic bag and immediately take it in for repair. Otherwise, pressure inside the watch will increase, and parts (crystal, crown, push button, etc.) may come off.



CAUTION

When Wearing Your Watch

<Band>

- Leather, genuine skin and rubber (urethane) bands will deteriorate over time due to perspiration, body oils and dirt. Be sure to replace the band periodically.
- The durability of a leather band may be affected when wet (fading, peeling of adhesive), owing to the properties of the material. Moreover, wet leather may cause a rash.
- It is recommended to take off the watch if it gets wet, even if the watch itself is water resistant.
- Do not wear the band too tightly. Try to leave enough space between the band and your skin to allow adequate ventilation.
- The rubber (urethane) band may be stained by dyes or soil present in or on clothing or other accessories. Since these stains may not be removable, caution is required when wearing your watch with items that tend to easily transfer color (articles of clothing, purses, etc.). In addition, the band may be deteriorated by solvents or moisture in the air. Replace with a new one when it has lost elasticity or become cracked.

Precautionary items and usage limitations

- Please request adjustment or repair of the band in the following cases:
 - You notice an abnormality with the band due to corrosion.
 - The pin of the band is protruding.
- We do not recommend attempting to adjust the watch band yourself. Special expertise and experience is required for proper adjustment. If not adjusted correctly, the band may become detached leading to loss of your watch. (Some retailers may supply a band adjustment tool with your purchase).
For band adjustment, we recommend you consult the retailer from where the watch was purchased or your nearest Authorized Citizen Service Center. Some repair shops may charge a nominal fee for adjustment if the watch was not purchased directly from them.

<Temperature>

- The watch may stop or the function of the watch may be impaired in extremely high or low temperature. Do not use the watch in places where the temperature is outside the operating temperature range as stated in the specifications.

<Magnetism>

- Analog quartz watches are powered by a step motor that uses a magnet. Subjecting the watch to strong magnetism from the outside can cause the motor to operate improperly and prevent the watch from keeping time accurately.
Do not allow the watch to come into close proximity to magnetic health devices (magnetic necklaces, magnetic elastic bands, etc.) or the magnets used in the latches of refrigerator doors, clasps used in handbags, the speaker of a cell phone, electromagnetic cooking devices and so on.

Precautionary items and usage limitations

<Strong Shock>

- Avoid dropping the watch or subjecting it to other strong impact. It may cause malfunctions and/or performance deterioration as well as damage to the case and bracelet.

<Static Electricity>

- The integrated circuits (IC) used in quartz watches are sensitive to static electricity. Please note that the watch may operate erratically or not at all if exposed to intense static electricity.

<Chemicals, Corrosive Gasses and Mercury>

- If paint thinner, benzene or other solvents or products containing these solvents (including gasoline, nail-polish remover, cresol, bathroom cleaners and adhesives, water repellent, etc.) are allowed to come into contact with the watch, they may discolor, dissolve or crack the materials. Be careful when handling these chemicals. Contact with mercury such as that used in thermometers may also cause discoloration of the band and case.

<Protective Stickers>

- Be sure to remove any protective stickers that may be on your watch (case back, band, clasp, etc.). Otherwise, perspiration or moisture may enter the gaps between the protective stickers and the parts, which may result in a skin rash and/or corrosion of the metal parts.

Precautionary items and usage limitations

CAUTION Always Keep Your Watch Clean

- Rotate the crown while it is pressed in fully and press the buttons periodically so they do not become stuck due to accumulations of foreign matter.
- The case and band of the watch come into direct contact with the skin in the same manner as undergarments. Corrosion of the metal or unnoticed soiling such as that caused by perspiration and dirt can soil sleeves and other portions of clothing. Keep your watch clean at all times.
- The case and band of the watch come into direct contact with the skin. If you think there is something wrong, discontinue wearing the watch immediately and consult your physician. In the case of accumulation of sweat or dirt on a metal band or case, clean thoroughly using a brush and neutral detergent. In the case of a leather band, wipe clean using a dry cloth.
- Leather bands may become discolored by perspiration or dirt. Always keep your leather band clean by wiping with a dry cloth.

Caring for Your Watch

- Wipe any dirt or moisture such as perspiration from the case and crystal with a soft cloth.
- For a metallic, plastic or rubber (urethane) watchband, wash any dirt off with water.
Remove the small amounts of dirt trapped between the crevices of the metallic band with a soft brush.
- For a leather band, wipe off dirt using a dry cloth.
- If you will not be using your watch for an extended period of time, carefully wipe off any perspiration, dirt or moisture and store in a proper location, avoiding locations subject to excessively high or low temperatures and high humidity.

<When Luminous Paint is used for your watch>

The paint on the dial and hands helps you with reading the time in a dark place. The luminous paint stores light (daylight or artificial light) and glows in a dark place. It is free from any radioactive substance or any other material harmful to a human body or environment.

- The light emission gradually becomes weaker as time passes.
- The duration of the light (“glow”) will vary depending on the brightness, types of and distance from a light source, exposure time, and the amount of the paint.
- The paint may not glow and/or may dissipate quickly if exposure to light was not sufficient.

Information

◆ The time signal

The time signal is broadcast almost continuously 24-hours a day, but may occasionally be interrupted due to maintenance. The broadcasting conditions of the time signal for Japan can be checked on the English web site of Japan Standard Time Project (<http://jty.nict.go.jp/index-e.html>).

The time signal has no effect on the human body or medical equipment.

◆ To avoid hand misalignment by impacts or magnetism—Perfex

Three features combined together prevent misalignment of the hands caused by external factors such as impact and magnetism.

JIS Type-1 antimagnetic performance:

This watch maintains its time functionality as close as 5 cm away from devices that generate a magnetic field during normal use.

Impact detection function:

This function prevents unwanted movement of the hour, minute and second hands when the watch receives an impact.

Automatic hand correction function (hand reference position auto-correction function):

The reference position of the hands is checked at regular intervals. If any misalignment is caused, the hour, minute and second hands are rapidly corrected to maintain the correct time.

Perfex
パーフェックス

Warranty and service

<Free Guarantee>

In the case a malfunction has occurred during the course of normal use while the watch is still under warranty, the watch will be repaired free of charge in accordance with the conditions of the warranty included with this manual.

<Stock Period of Repair Parts>

Our standard period for stocking repair parts for each model is generally seven years. When an exterior part such as the watch case, glass, dial, hand, crown or band is damaged, a spare part with different appearance may sometimes be used.

<Repair Period>

Repairs can be performed on your watch within the repair parts stock period even after the free guarantee has expired. However, you will be charged for these repairs. Please take the watch to the shop where you purchased it and ask whether it can be repaired because the repair period varies according to the conditions of use, environment and so forth. Moreover, there are cases in which it is difficult to restore the watch to its original accuracy when decreased accuracy has resulted from long-term use.

<Change of Address or Receiving as a Gift>

In the event that you have moved or have received your watch as a gift, and are not able to bring your watch to the shop where it was purchased for servicing, please consult Customer Support Center.

<Periodic Inspection (Charge Basis)>

- Water resistance

As the water resistance will be reduced over time, you should have your watch inspected and its water resistance verified every 2-3 years (charge basis) to extend its life and ensure safety. To maintain its water resistance, it is recommended to request us to replace the packings and other parts of your watch.

- Disassembling for internal cleaning (repair)

You should have your watch disassembled and its internal components cleaned periodically to extend its life. Lubrication oils are used to reduce wearing of moving parts such as gears. However, over time the lubrication oils will degrade and wear will increase, eventually resulting in malfunction. Please have your watch undergo internal cleaning every 3-5 years (although the maintenance frequency depends on the usage circumstances).

<Request to Customers>

All parts of this watch, except for the band, are to be repaired only at CITIZEN.

This is because special technologies and equipment are required to perform repairs, inspections and adjustments. Please make requests for repairs to Customer Support Center when having your watch repaired.

<Other Inquiries>

If you have any questions regarding the warranty, repairs or other matters, please inquire at the shop where you purchased your watch or Customer Support Center.

Specifications

Model	H80*	Type	Analog solar-powered watch
Timekeeping accuracy (without the time signal reception)	Within ± 15 seconds per month when worn at normal operation temperatures (between $+5^{\circ}\text{C}$ and $+35^{\circ}\text{C}$)		
Operating temperature range	- 10°C to $+60^{\circ}\text{C}$		
Display functions	<ul style="list-style-type: none">• Time: Hours, minutes, seconds, 24-hour time• Calendar: Date, day of the week• Power reserve: 4 levels		
Maximum run time from full charge	<ul style="list-style-type: none">• Fully charged to fully discharged:<ul style="list-style-type: none">Approximately ten months (with power save feature)Approximately six months (without power save feature)• Power reserve upon insufficient charge warning function:<ul style="list-style-type: none">Approximately two days <p>* Maximum run time shown is effective under following conditions.</p> <ul style="list-style-type: none">• The chronograph is used once per day for 60 minutes.• The automatic reception is performed once per day.		

Battery	Rechargeable cell (lithium button cell), 1pc.
Additional functions	<ul style="list-style-type: none"> • Solar power function • Overcharging prevention function • Insufficient charge warning function (two-second interval movement) • Energy saving function (power save feature) • Receiving time signal (automatic, on demand, automatic recovery) Signal stations: Japan (East/West)/USA/Germany/China * When the time difference is corrected, the signal station is switched. • Indicating the state of reception (RX, OK or NO) • Indicating the result of the last reception • Automatic selection of time signal stations • Summer Time (ON/OFF, Auto/Manual) • Chronograph (up to 60 minutes in 1/20 second increments) • City setting (26 cities) • Perpetual calendar (until February 28th, 2100) • Perfex (JIS Type-1 antimagnetic performance/Impact detection function/ Automatic hand correction function) • Checking and correcting the reference position

Specifications are subject to change without prior notice.

<http://citizen.jp/>